

# The Surveyor

## Cutting Edge Thermal Imaging Camera Systems

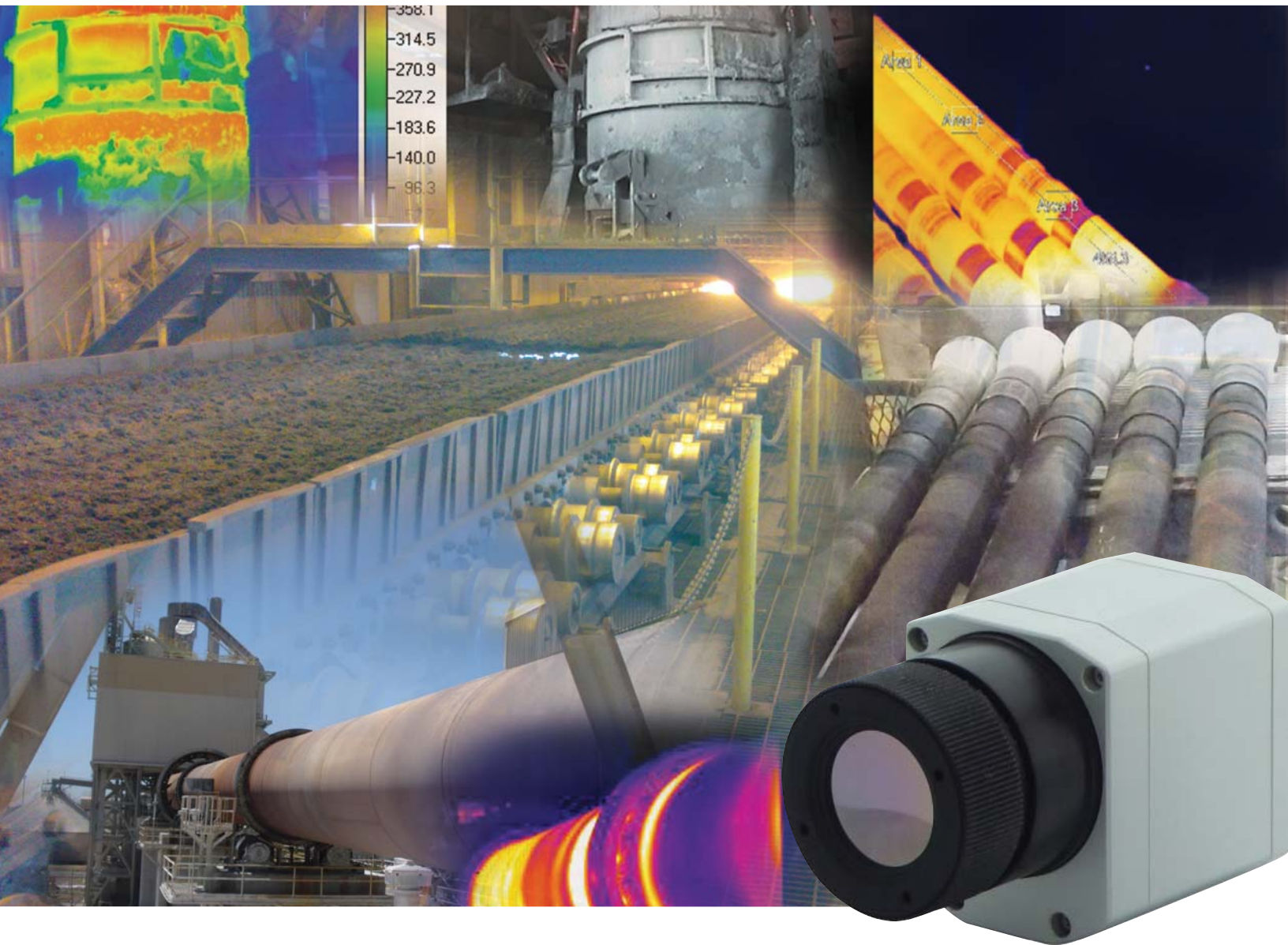

Strategic Solutions for Process Measurement and Control Applications

# PSC SURVEYOR IR IMAGING SERIES CAMERAS MONITOR AND CONTROL PROCESS TEMPERATURES IN REAL TIME

- Temperature Measurement Ranges from -20°C to 1500°C
- Complete Turn-Key Process Control Systems
- High Resolution—Over 300,000 Points of Temperature Measurement
- Ultra-Small, Light Weight Cameras—Ideal for OEM Applications
- Choice of Process Control Outputs, Milliamp Voltage or Solid State Alarm Relays
- Real-Time Imaging and Recording up to 128 Hz
- Simple-to-use Intuitive and Powerful Software
- Designed For Compatibility and Integration With Existing Systems
- USB, Ethernet or Fiber Optic Connectivity
- Wide Selection of Focusable Lenses
- Custom Solutions Including Field PC's, Touch Screen Displays and Process Control Interface
- Digital Interfaces Include Ethernet I/P, Modbus RTU, Modbus, Profibus, Profinet, Devicenet

## **PROCESS SENSORS ULTRA COMPACT CAMERA DESIGNS YIELD HUGE RESULTS**

IR Imaging Cameras are compact, radiometric and enable the operator to view and measure thousands of temperature points, line profiles or user selectable areas or regions of interest (ROI's) defined by a maximum, minimum or average temperature within these regions. The smart technology and space saving design of each model brings new meaning to the word "simplicity" and sets a benchmark for quality and performance.

## **INTERCHANGEABLE LENSES**

User selectable, precision lenses provide clear, crisp images and define the rectangular area of measurement. Standard, wide angle or telephoto optics are available.

## **INSTANT DEFECT ALERTS SAVE RESOURCES**

Only 8 milliseconds to detect and diagnose a temperature anomaly that can prevent a costly shut-down of your production line. That's all the time it takes for the new PSC IR Imaging process measurement and control system cameras to alert you of a potential problem.

## **60 SECOND SET UP**

Designed for instant-on operation, the PSC IR Imaging Cameras boast Sixty Second Set Up. Connecting a camera to the USB port of a standard PC yields crisp, clear real-time images instantly, giving the operator ready access and immediate control of the camera functionality and process.

## **HIGH SPEED AND CONTROL**

These state of the art camera systems provide real-time thermography with an astonishing 128 Hz frame rate. The systems can be remotely triggered to respond to fast occurring events, initiating alarms, outputs or capturing and recording data to a network for later retrieval and analysis.

## **COMPACT DURABILITY**

Very compact and equally rugged, the highly reliable PSC IR Imaging Cameras are easily incorporated into test stations and existing process automation control systems. Designed for unattended operation, they are ideal for installations where space is limited but data collection is essential. Virtually impervious to environmental conditions, the protective watercooled/air purged camera housing is designed to protect the cameras in extreme conditions.

## **MYRIAD APPLICATIONS**

The PSC IR Cameras are ideal for use in mechanical stress analysis as well as monitoring furnace walls and kiln shells. Other applications include research and development, solar panels, flat glass, gypsum board, wood, paper converting, plastics, rubber thermoforming, food processing, conveying of bulk solids and powder, and rotating machinery.

# PSC-640 High Resolution Radiometric Thermal Imaging Camera



## *IMPRESSIVE FEATURES:*

- High Spatial Resolution of 640 x 480 pixels (300,000 points of temperature measurement)
- Radiometric Video Recording with 32 Hz frame rate
- Smallest Measuring Thermal Imaging Array Camera Worldwide (46mm x 56mm x 90mm)
- License-free, All-inclusive, Powerful Analysis & Software Development Kit (SDK)
- Adjustable Focus Optics
- Close Focus Measuring Distance from 0.8" (20mm).
- Measuring Pixel Spot Size down to 0.004" (0.1mm)
- Lens Choices: 33° x 25°, 60° X 45°, 90° X 66°
- USB powered
- Wavelength: 7.5–13  $\mu$ m

## User Selectable Temperature Ranges:

-20 to 100°C (-4 to 212°F)

0 to 250°C (32 to 482°F)

150 to 900°C (302 to 1652°F)

200 to 1500°C (392 to 2732°F) Optional

## POWERFUL SOFTWARE

PSC Camera Connect, the user-intuitive menu-driven real time software sets new standards with its simplicity, versatility and functionality. The unlicensed and unrestricted software allows the operator to combine variable points with crosshair targeting and programmable areas of measurement with automatic displays of maximum, minimum or average temperature readings within assigned areas with multiple, user selectable regions of interest (ROI's).

The software opens a wide range of functionality options to the user with five different color pallet selections that include iron, rainbow, black-white, black-white inverted, and ice and fire. Ready to use measurement and display layouts (predefined templates) as well as video editing functions, yield fast results and make archiving data simple.



## High Resolution PSC-400 / PSC-450 Thermal Imaging Camera Models



- Detector with 382 x 288 pixels (110,000 points of temperature measurement)
- Fast, real-time thermal imager with up to 80 Hz frame rate
- Excellent thermal sensitivity of 80mK and 40mK
- Smallest cameras in their class (1.8" x 2.2" x 3.5")
- Lightweight (11.28 oz. including optics)
- Exchangeable focusable lenses with rugged industrial accessories
- Wavelength: 7.5–13  $\mu\text{m}$

### User Selectable Temperature Ranges:

-4 to 212°F (-20 to 100°C)

32 to 482°F (0 to 250°C)

302 to 1652°F (150 to 900°C)

The PSC-400 imaging camera is available with an additional optional range of 392 to 2732°F (200 to 1500°C).

### FLEXIBLE VERSATILITY

Three readily exchangeable lenses (23° x 17° standard, 6° x 5° close focus, and 48° x 37° wide angle) allow effortless transition from one application to another as dictated by the overall field of view (area of measurement) that is required. The PSC Infrared Online Camera Systems feature a selection of temperature ranges designed to fit a wide range of applications. The cameras include line profile and scanner functionality which enable the operator to switch between the thermal imaging camera and line scanner profile mode. The cameras will provide 200 temperature points of high speed measurement in the line scan mode.

### SEE ALL DATA AT A GLANCE

A wealth of information is available at a glance: the IR live image from the camera, temperature profile graphs of two lines, a reference bar that illustrates the scaling, the temperature of the measured area, a histogram showing the statistical temperature distribution, a control function that allows manual activation of flags, display of ambient temperature at the camera location with alarm notification, and the temperature of each individual pixel by moving a cursor within the image.

### IN THE ZONE

User assigned ROI's (Regions of Interest) of preferred size can be configured anywhere on the thermal image to illustrate the maximum, minimum or average temperature value. Control outputs can then be assigned to these area values with multiple programmable alarm functionality.

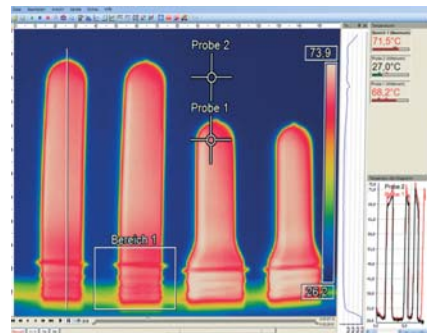

*At higher resolution over 5 times more pixels can be used.*

The cameras display and store thermal images with high resolution (382 x 288 pixels) at full frame rate of 80 Hz (80 images per second).



# PSC-450-G7 Thermal Imaging / Line Scan Solution For The Glass Industry

## Impressive Features:



- Designed specifically for Glass Industry Applications
- Real Time Thermal Images at 80 Hz Frame Rate, Switchable to 27 Hz
- High Spatial Resolution (382 x 288 pixels)
- Line Scanning Capabilities for Sheet Glass Production
- License-free, All-inclusive, Powerful Analysis & Software
- Software Development Kit (SDK) included
- Adjustable Focus Optics
- Interchangeable Lenses and Industrial Accessories Available
- Wavelength: 7.9  $\mu\text{m}$

The PSC-450-G7 infrared camera is the first industry-specific thermal imaging camera in the Surveyor IR Imaging Series. Designed specifically for the glass industry, the PSC-450-G7 measures in the 7.9 $\mu\text{m}$  spectral range with a temperature range from 200 to 1500°C. Also included is a visible range from 0-250C and is used only for observing objects at low temperatures.

The same compact enclosure design as our PSC-400 and PSC-450 models (46 x 56 x 90mm) ensures easy integration to existing systems. The heavy duty stainless steel cooling jacket allows camera operation in ambient temperatures of up to 200°C.



## PSC-764-1M

### Highly Accurate, Short Wavelength Infrared Camera Designed For The Metals Industry

#### Outstanding Features:

- Flexible CMOS Detector providing high noise immunity and low static power consumption
- High Optical Resolution of up to 764 x 480 pixels at 32 Hz and 382 x 288 pixels at 80 Hz
- High speed analog output @ 1 kHz mode, 0–10 V real time output of the center pixel (1 ms response time)
- Wide Temperature Range of 450° to 1800°C for all fields of metal production and processing
- Fast Frame Rate up to 80 Hz
- Combination of Thermal Imaging or Line Scanning Capabilities (switchable)
- License-free, All-inclusive, Powerful Real-Time Analysis Software (SDK included)
- Interchangeable Lenses and Industrial Accessories Available
- Wavelength: 1.1  $\mu\text{m}$



Designed specifically for the metals industry, the PSC-764-1M camera with short-wave filter provides accurate temperature measurement of semi/shiny metals as it outperforms much better than long wave cameras as its short wavelength is designed to be less sensitive to emissivity changes on the product's surface. Hot Rolling Mill, Induction Heating, Medical, Aerospace and R&D applications are ideal applications for the High resolution, high accuracy model PSC-764-1M camera.

An image or a series of images can be recorded, stored and later retrieved via customer's network for analysis and quality control purposes.

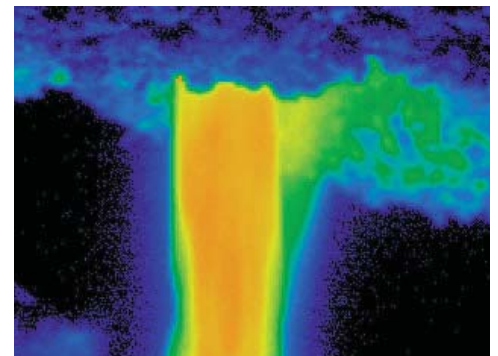
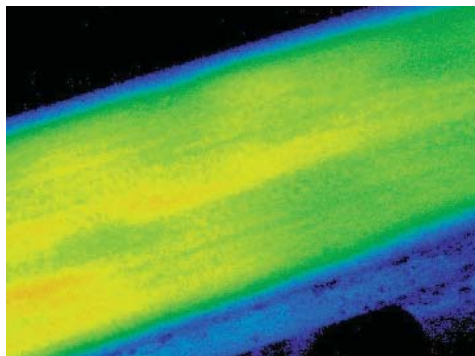
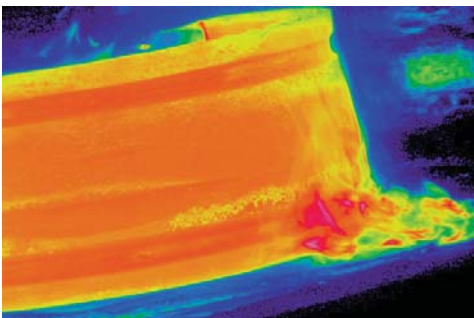

## PSC-160 Infrared Camera with 120 Hz Frame Rate



### Important Features

- Outstanding price-performance ratio
- Detector with 160 x 120 pixels (19,200 measurement points)
- Real time thermal imaging with up to 120 Hz frame rate
- High resolution thermal sensitivity
- Compact design (1.77" x 1.77" x 2.44")
- A variety of lens choices
- Wavelength: 7.5–13  $\mu\text{m}$



## TRUE RADIOMETRIC VALUE

Equipped with simple to use, powerful and intuitive software, the cost effective PSC-160 offers real time temperature readings at any point in the monitored field and can identify unseen trouble spots while they can still be corrected, improving product quality and increasing yield.

The PSC-160 camera housing is rated Protection Class IP67 (NEMA-4). Ambient temperature capability is 122°F. Air and water cooled jackets increase operating temperature capability to 212°F and 465°F respectively.

Accessories for adaptation to a wide range of applications and multiple system configurations:

- Custom mounting systems
- High temperature cables
- Process control interface with alarms and multiple outputs
- Industrial enclosures with explosion proof housings
- Touch screen PC's

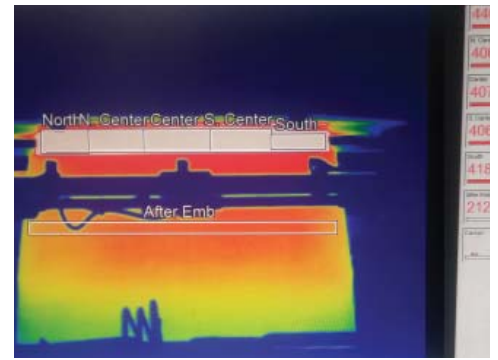
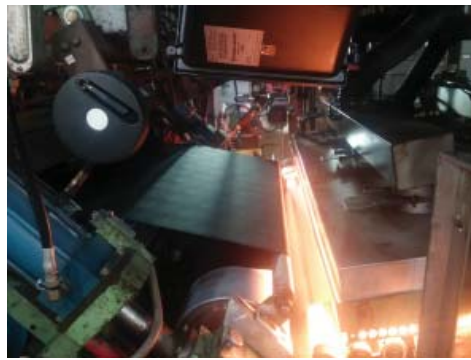
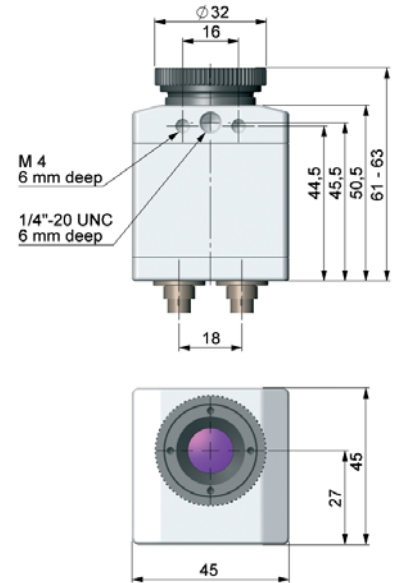

# PSC Camera Connect Software Line Scanner Mode

The PSC Camera Connect Software includes a line scanner function. The line scanner mode is generally used for processes with moving objects under test, such as temperature measurement of rotary kilns, monitoring of materials on conveyor belts or paper webs.

Advantages of Line Scanner Mode:

- Simplified monitoring of process with limited optical access
- Indirect visualization of heat distribution within ovens via camera installation at oven exit
- Increase from 160 pixels up to 200 pixels by using diagonal screen of image.
- Up to 128 Hz data recording of unlimited lines, producing thermal images of desired resolution
- Up to 100° FOV as a line for detailed process analysis surveying wide areas.



Application example: Rotary kiln within the chemical industry

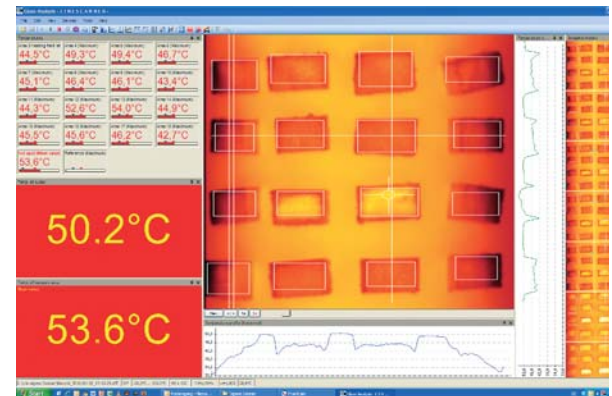

Example of linescanner function display layout

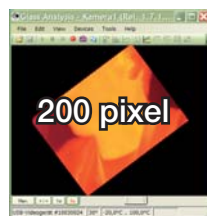
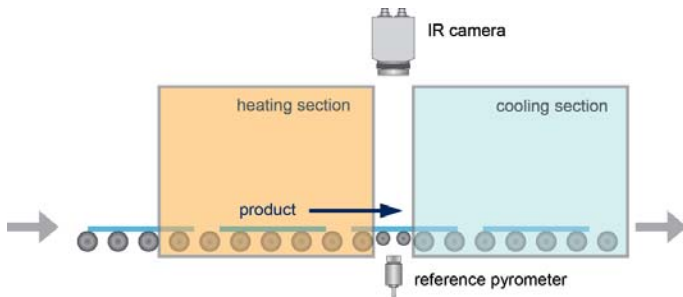

## Three simple steps to initialize Line Scanning

1. Activate the camera Line Scanner function and define the position of the line in the thermal image.
2. Select and set up custom function desired, e.g. the number of displayed lines, or trigger definition for automatic image storage.
3. Define individual custom layouts, e.g. display of stored images in snapshot history.



# Important Features of the PSC Surveyor IR Imaging Camera Series

## Easy Process Integration

Advanced interface concepts allow seamless integration within networks and automated systems:

- USB, Ethernet or Fiber Optic
- Capture image or a sequence of images via an external voltage signal, a maximum temperature, deltaT or manually.
- Process Interface (PIF) at the camera providing analog input/output (0 to 10V) used for alarms and digital input (low- and high-level)
- Software interface via Dynamic-Line Library (DLL), Computer-Port (ComPort).
- Digital interfaces include Ethernet I/P, Modbus RTU, Modbus I/P, Profibus, Profinet, Devicenet.

## Fast Measurements

Temperature distribution of a material, product or event can be captured precisely within milliseconds.

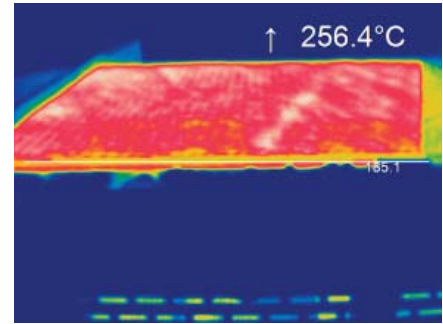

Processes can be examined thermally and deviating hot or cold positions are pinpointed automatically. Temperature distribution of a surface can be captured precisely within millisecond intervals

## CUSTOM TURN-KEY SOLUTIONS

IR Imaging systems packages include touchscreen pcs, process control interface with alarms in multiple outputs, and industrial enclosures with explosion proof housings making custom installations simple for integration with existing process and control systems. Engineering support from experienced application specialists guides users through every step of the design process, ensuring high quality with guaranteed results.

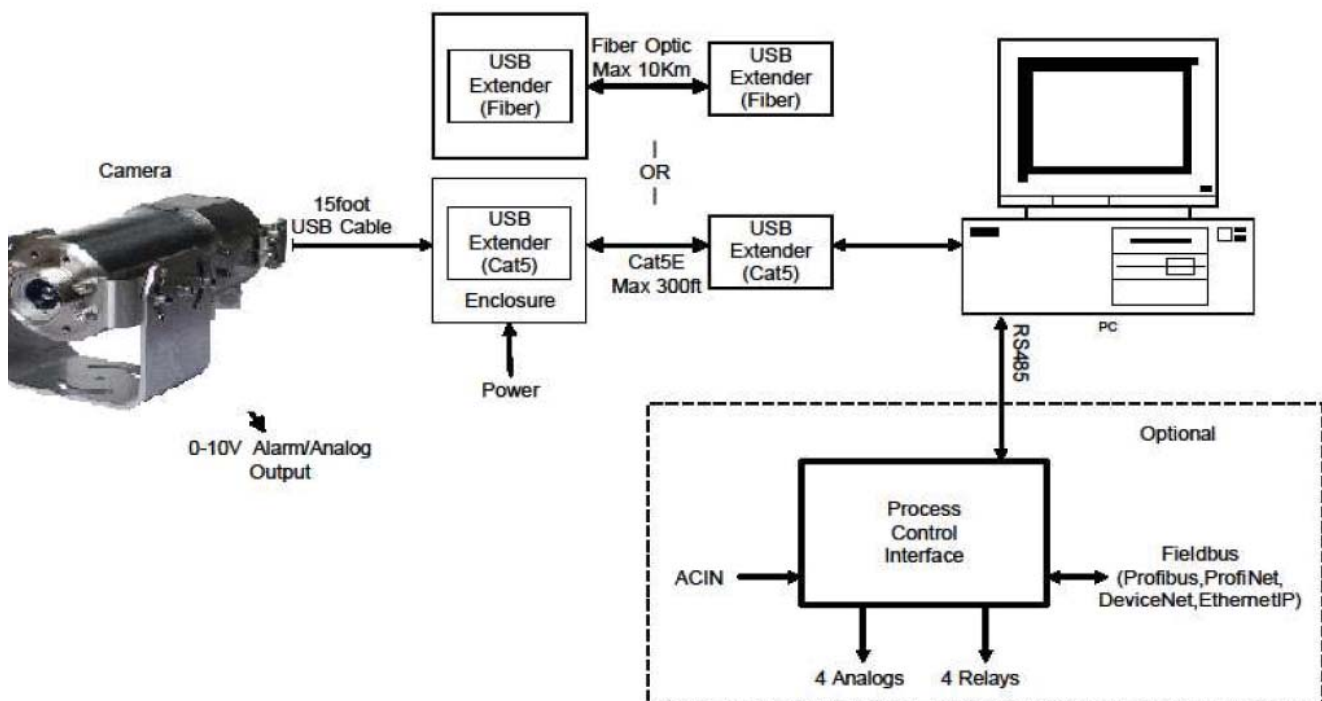

# PSC CAMERA CONNECT

## Extensive infrared camera software

- No additional costs
- No restrictions in licensing
- Modern software with intuitive user interface
- Remote control of camera via software
- Display of multiple camera images in different windows
- Compatible with Windows 7, 8, and 10, as well as Linux (ubuntu)
- Extensive license-free analysis and complete SDK inclusive



## High level of individualization for customer

- Different layout options for an individual setup (arrangement of windows, toolbar)
- Temperature display in °C or °F
- Language options including a translation tool
- Range of individual measurement parameters appropriate for each application
- Adaption of thermal image (mirror, rotate)
- Individual start options (full screen, hidden, etc.)

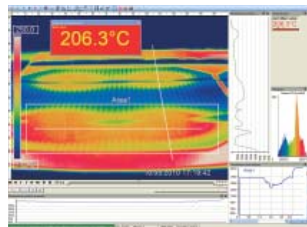

## Video recording function

- Recording of video sequences and detailed frames for further analysis or documentation
- Adjustment of recording frequency to reduce data volume
- Display of snapshot history for immediate analysis

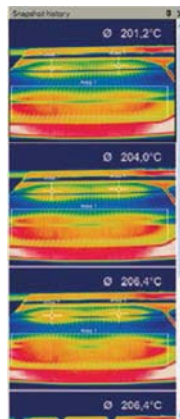

## Extensive online and offline data analysis

- Real-time temperature information within main window as digital or graphic display
- Analysis supported by measurement fields, automatic hot and cold spot searching
- Logic operation of temperature information (measurement fields and image subtraction)
- Slow motion repeat of radiometric files and analysis without camera being connected
- Editing of sequences such as cutting and saving of individual images
- Various color palettes to highlight thermal contrasts

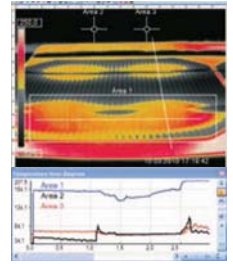

## Automatic process and quality control

- Individual setup of alarm levels depending on the process
- Definition of visual or acoustic alarms and analog data output via the process interface
- Analog and digital signal input (process parameter)
- External communication of software via Comports and DLL
- Adjustment of thermal image via reference values





## Temperature data analysis and documentation

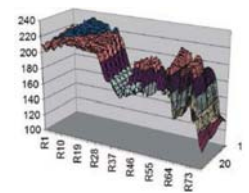

- Triggered data collection
- Radiometric video sequences (\*.ravi)
- Radiometric snapshots (\*.tiff)
- Text files including complete temperature information for analysis in Excel (\*.csv, \*.dat)
- Data with color information for standard programs such as Photoshop or Windows MediaPlayer (\*.avi, \*.tiff)
- Data transfer in realtime to other software programs via DLL or Comport interfaces



## PSC Thermal Imaging Camera Series Specifications

MODEL	PSC-640	PSC-450	PSC-450-G7
			
<b>Standard Equipment</b>	USB Camera including 1 lens, 1 meter USB cable, table tripod, 1 meter PIF cable including terminal block, PSC Camera Connect software package, aluminum carrying case	USB Camera including 1 lens, 1 meter USB cable, table tripod, 1 meter PIF cable including terminal block, PSC Camera Connect software package, aluminum carrying case	USB Camera including 1 lens, 1 meter USB cable, table tripod, 1 meter PIF cable including terminal block, PSC Camera Connect software package, aluminum carrying case
<b>Detector</b>	FPA, uncooled (17µm x 17µm)	FPA, uncooled (25 µm x 25 µm)	FPA, uncooled (17 µm x 17 µm)
<b>Optical Resolution</b>	640 x 480 pixels	382 x 288 pixels	382 x 288 pixels
<b>Spectral Range</b>	7.5 - 13µm	7.5 - 13 µm	7.9µm
<b>Temperature Ranges</b>	-4 to 212°F (-20 to 100°C) 32 to 482°F (0 to 250°C) 302 to 1652°F (150 to 900°C) Additional Optional Range: 392 to 2732°F (200 to 1500°C)	-4 to 212°F (-20 to 100°C) 32 to 482°F (0 to 250°C) 302 to 1652°F (150 to 900°C) Additional Optional Range: 392 to 2732°F (200 to 1500°C)*	200 to 1500°C (392 to 2732°F)  Visual Sighting Range: 0 to 250°C (32 to 482°F) No Temp Data
<b>Frame Rate</b>	32 Hz	80 Hz	80 Hz / Switchable to 27 Hz
<b>Optics (Field Of View)</b>	33° x 25° 60° X 45° 90° X 66°	32° x 24° 62° x 49° 13° x 10°	38° x 29° 62° x 49°
<b>Thermal Sensitivity (NETD)</b>	75 mK	0.04 K with 38° x 29° FOV/F = 0.8 0.04 K with 62° x 49° FOV/F = 0.8 0.06 K with 13° x 10° FOV/F = 1.0	130 mK
<b>Line Scanning Function</b>			License-free analysis software PSC-Camera connect
<b>Accuracy</b>	±2°C or ±2%, whichever is greater	±2°C or ±2%	±2°C or ±2%, whichever is greater
<b>PC Interface</b>	USB 2.0	USB 2.0	USB 2.0
<b>Process Interface (PIF)</b>	0-10V input, digital input (max. 24V), 0-10V output 2x 0-10V inputs, digital input (max.24V), 3x 0-10V outputs, 3x relay (0-30V/400mA), fail safe relay	0 - 10 V input, digital input, 0 - 10 V output	0-10V input, digital input (max. 24V), 0-10V output 2x 0-10V inputs, digital input (max.24V), 3x 0-10V outputs, 3x relay (0-30V/400mA), fail safe relay
<b>Ambient Temperature</b>	32 to 122°F ( 0 to 50°C)	32 to 158°F ( 0 to 70°C)	32 to 158°F (0 to 70°C)
<b>Storage Temperature</b>	-40 to 158°F (-40 to 70°C)	-40 to 185°F (-40 to 85°C)	-40 to 185°F (-40 to 85°C)
<b>Relative Humidity</b>	20 - 80%, non-condensing	20 - 80%, non-condensing	20 to 80%, non-condensing
<b>Enclosure Size And Rating</b>	1.81" x 2.20" x 3.54" (46mm x 56mm x 90mm) IP 67 (NEMA 4)	1.81" x 2.2" x 3.54" (46mm x 56mm x 90mm) IP 67	1.81" x 2.20" x 3.54" (46mm x 56mm x 90mm) IP 67 (NEMA 4)
<b>Weight</b>	11.28 oz. (320 grams) including lens	0.70 lb. (320 grams) including lens	11.28 oz. (320 grams) including lens
<b>Shock / Vibration</b>	IEC 60068-2-27 (25g and 50g) IEC 60068-2-6 (sinus-shaped) IEC 60068-2-64 (broadband noise)	25G, IEC 68-2-29 / 2G, IEC 68-2-6	IEC 60068-2-27 (25g and 50g) IEC 60068-2-6 (sinus-shaped) IEC 60068-2-64 (broadband noise)
<b>Tripod Mount</b>	1/4-20 UNC	1/4-20 UNC	1/4-20 UNC
<b>Power Supply</b>	USB Powered	USB Powered	USB Powered

## PSC Thermal Imaging Camera Series Specifications

MODEL	PSC-400	PSC-160	PSC-764-1M
			
<b>Standard Equipment</b>	USB Camera including 1 lens, 1 meter USB cable, table tripod, 1 meter PIF cable including terminal block, PSC Camera Connect software package, aluminum carrying case	USB Camera including 1 lens, 1 meter USB cable, table tripod, 1 meter PIF cable including terminal block, PSC Camera Connect software package, aluminum carrying case	USB camera with 1 lens, Lens cap incl. protective window, USB cable (1 m), Table-top tripod, PIF cable with connecting terminal strip (1 m), PSC Camera Connect software package, aluminum carrying case
<b>Detector</b>	FPA, uncooled (25 µm x 25 µm)	FPA, uncooled (25 µm x 25 µm)	CMOS (15 µm x 15 µm)
<b>Optical Resolution</b>	382 x 288 pixels	160 x 120 pixels	764 x 480 pixels @ 32 Hz 382 x 288 pixels @ 80 Hz 72 x 56 pixels @ 1000 Hz
<b>Spectral Range</b>	7.5 - 13 µm	7.5 - 13 µm	0.92 – 1.1 µm
<b>Temperature Ranges</b>	-4 to 212°F (-20 to 100°C) 32 to 482°F (0 to 250°C) 302 to 1652°F (150 to 900°C) Additional Optional Range: 392 to 2732°F (200 to 1500°C)*	-4 to 212°F (-20 to 100°C) 32 to 482°F (0 to 250°C) 302 to 1652°F (150 to 900°C) Additional Optional Range: 392 to 2732°F (200 to 1500°C)*	450 ... 1800 °C (32 and 27 kHz mode) 500 ... 1800 °C (80 kHz mode) 600 ... 1800 °C ( 1 kHz mode)
<b>Frame Rate</b>	80 Hz	120 Hz	32 Hz, 80 Hz, 1000 Hz
<b>Optics (Field Of View)</b>	38° x 29° 62° x 49° 13° x 10°	23° x 17° 6° x 5° 41° x 31° 72° x 52°	FOV @ 382x288 px      FOV @ 764x480 px 51° x 39°              87° x 62° 26° x 20°              51° x 33° 20° x 15°              39° x 25° 13° x 10°              26° x 16° 7° x 5°                 13° x 8° 4° x 3°                 9° x 5°
<b>Thermal Sensitivity (NETD)</b>	0.08 K with 38° x 29° FOV/F = 0.8 0.08 K with 62° x 49° FOV/F = 0.8 0.1 K with 13° x 10° FOV/F = 1.0	0.08 K with 23° x 17° FOV/F = 0.8 0.3 K with 6° x 5° FOV/F = 1.6 0.1 K with 41° x 31° FOV/F and 72° x 52° FOV/F = 1	< 1 K (700 °C) < 2 K (1000 °C)
<b>Accuracy</b>	±2°C or ±2%	±2°C or ±2%	±2 °C or ±2 %, whichever is greater
<b>PC Interface</b>	USB 2.0	USB 2.0	USB 2.0
<b>Process Interface (PIF)</b>	0 - 10 V input, digital input, 0 - 10 V output	0 - 10 V input, digital input, 0 - 10 V output	0 – 10 V input, digital input (max. 24 V), 0 – 10 V output
<b>Ambient Temperature</b>	32 to 122°F ( 0 to 50°C)	32 to 122°F ( 0 to 50°C)	0 ... 50 °C
<b>Storage Temperature</b>	-40 to 158°F (-40 to 70°C)	-40 to 158°F (-40 to 70°C)	- 40 ... 70 °C
<b>Relative Humidity</b>	20 - 80%, non-condensing	20 to 80%, non-condensing	20 – 80 %, non-condensing
<b>Enclosure Size And Rating</b>	1.81" x 2.2" x 3.54" (46mm x 56mm x 90mm) IP 67	1.77" x 1.77" x 2.44" (45mm x 45mm x 62mm) IP 67	46 mm x 56 mm x 90 mm / IP 67 (NEMA 4)
<b>Weight</b>	0.70 lb. (320 grams) including lens	0.42 lb. (195 grams) including lens	320 g, incl. lens
<b>Shock / Vibration</b>	25G, IEC 68-2-29 / 2G, IEC 68-2-6	25G, IEC 68-2-29 / 2G, IEC 68-2-6	IEC 60068-2-27 (25 g und 50 g) IEC 60068-2-6 (sinus-shaped)
<b>Tripod Mount</b>	1/4-20 UNC	1/4-20 UNC	1/4 - 20 UNC
<b>Power Supply</b>	USB Powered	USB Powered	USB Powered

# PSC High Performance Camera Series Optical Specifications

A choice of lenses offers the possibility to precisely measure object temperature at different distances. Choose from standard, close focus and telephoto lenses. A selection of precision lenses are available for individual applications.

When choosing a lens, the following points should be considered:

- **HFOV:** Horizontal enlargement of the total measuring field
- **VFOV:** Vertical enlargement of the total measuring field
- **IFOV:** Size of the single pixel
- **MFOV:** Recommended, smallest measured object size of 3 x 3 pixels

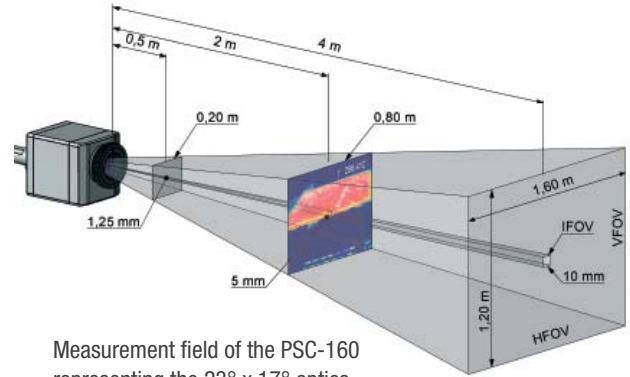

Measurement field of the PSC-160 representing the 23° x 17° optics.

The measurement area (FOV) is determined by the appropriate lens selection, meanwhile the individual spot sizes are determined by the camera's detector resolution, e.g., 160x120 or 382x288.

PSC-160/200 160 x 120 pixels	Focal Length	Angle	Min. Distance	Distance to Object												
				m	0.02	0.1	0.2	0.3	0.5	1	2	4	6	10	30	100
23° x 17° Standard lens	10 mm	23° 17° 29° 2.52 mrad	0.02 m*	HFOV [m]	0.008	0.04	0.08	0.12	0.20	0.40	0.81	1.61	2.42	4.0	12.1	40.3
				VFOV [m]	0.006	0.03	0.06	0.09	0.15	0.30	0.60	1.20	1.79	3.0	9.0	29.9
				DFOV [m]	0.010	0.005	0.10	0.15	0.26	0.51	1.02	2.04	3.06	5.1	15.3	51.1
				IFOV [mm]	0.1	0.3	0.5	0.8	1.3	2.5	5.0	10.1	15.1	25.2	75.6	252.0
8° x 5° Telephoto lens	35.5 mm	6° 5° 8° 0.71 mrad	0.5 m	HFOV [m]					0.06	0.11	0.23	0.45	0.68	1.1	3.4	11.3
				VFOV [m]					0.04	0.08	0.17	0.34	0.50	0.8	2.5	8.4
				DFOV [m]					0.07	0.14	0.28	0.56	0.84	1.4	4.2	14.1
				IFOV [mm]					0.4	0.7	1.41	2.8	4.2	7.1	21.2	70.5
41° x 31°	5.7 mm	41° 31° 52° 4.72 mrad	0.02 m*	HFOV [m]	0.015	0.08	0.015	0.23	0.38	0.76	1.51	3.02	4.53	7.6	22.7	75.6
				VFOV [m]	0.011	0.05	0.011	0.16	0.27	0.55	1.09	2.19	3.28	5.5	16.4	54.7
				DFOV [m]	0.019	0.10	0.019	0.29	0.49	0.97	1.95	3.90	5.85	9.7	29.2	97.5
				IFOV [mm]	0.1	0.5	0.1	1.4	2.4	4.7	9.5	18.9	28.3	47.2	141.7	472.3
72° x 52° Wide angle lens	3.3 mm	72° 52° 95° 9.08 mrad	0.21 m	HFOV [m]	0.029	0.15	0.29	0.44	0.73	1.45	2.91	5.81	8.72	14.5	43.6	145.3
				VFOV [m]	0.020	0.10	0.20	0.29	0.49	0.98	1.95	3.90	5.85	9.8	29.3	97.5
				DFOV [m]	0.043	0.22	0.43	0.65	1.09	2.17	4.34	8.68	13.02	21.7	65.1	217.0
				IFOV [mm]	0.2	0.9	1.8	2.7	4.5	9.1	18.2	36.3	54.5	90.8	272.5	908.2

PSC-400/450 /450-G7 322 x 288 pixels	Focal Length	Angle	Min. Distance	Distance to Object												
				m	0.02	0.1	0.2	0.3	0.5	1	2	4	6	10	30	100
38° x 29° Standard lens	15 mm	38° 29° 49° 1.81 mrad	0.2 m	HFOV [m]	0.014	0.07	0.14	0.21	0.35	0.69	1.39	2.77	4.16	6.9	20.8	69.3
				VFOV [m]	0.010	0.05	0.10	0.15	0.25	0.51	1.02	2.03	3.05	5.1	15.2	50.8
				DFOV [m]	0.018	0.09	0.18	0.28	0.46	0.92	1.84	3.68	5.52	9.2	27.6	92.0
				IFOV [mm]	0.1	0.2	0.4	0.5	0.9	1.8	3.6	7.3	10.9	18.1	54.4	181.3
13° x 10° Telephoto lens	41 mm	13° 10° 17° 0.61 mrad	0.5 m	HFOV [m]					0.12	0.23	0.47	0.94	1.40	2.3	7.0	23.4
				VFOV [m]					0.09	0.17	0.35	0.70	1.05	1.7	5.2	17.5
				DFOV [m]					0.15	0.29	0.58	1.17	1.75	2.9	8.8	29.2
				IFOV [mm]					0.3	0.6	1.2	2.5	3.7	6.1	18.4	61.2
62° x 49° Wide angle lens	8 mm	62° 49° 74° 3.14 mrad	0.5 m	HFOV [m]	0.024	0.012	0.24	0.36	0.60	1.20	2.40	4.80	7.20	12.0	36.0	119.9
				VFOV [m]	0.018	0.09	0.18	0.27	0.45	0.90	1.80	3.60	5.41	9.0	27.0	90.1
				DFOV [m]	0.030	0.15	0.30	0.45	0.75	1.50	3.00	6.00	8.99	15.0	45.0	149.9
				IFOV [mm]	0.1	0.3	0.6	0.9	1.6	3.1	6.3	12.6	18.8	31.4	94.2	314.0

\*Note: The accuracy of measurement can be outside of the specifications for distances below 0.2 m.

## PSC High Performance Camera Series Optical Specifications

PSC-640 640 x 480 pixels	Focal Length	Angle	Min. Distance	Distance to Object											
				m	0.1	0.2	0.3	0.5	1	2	4	6	10	30	100
33° x 25° Standard lens	18.7 mm	33° 25° 41° 0.909 mrad	0.2 m*	HFOV [m]	0.059	0.12	0.18	0.30	0.59	1.2	2.4	3.6	5.9	17.8	59.3
				VFOV [m]	0.044	0.088	0.13	0.22	0.44	0.88	1.8	2.6	4.4	13.2	44.1
				DFOV [m]	0.075	0.15	0.22	0.37	0.75	1.5	3.0	4.5	7.5	22.5	74.9
				IFOV [mm]	0.091	0.18	0.27	0.45	0.91	1.8	3.6	5.5	9.1	27.3	90.9
60° x 45° Wide angle lens	10.5 mm	60° 45° 75° 1.62 mrad	0.2 m	HFOV [m]	0.12	0.23	0.35	0.58	1.2	2.3	4.6	6.9	11.5	34.6	115.4
				VFOV [m]	0.082	0.16	0.25	0.41	0.82	1.6	3.3	4.9	8.2	24.7	82.4
				DFOV [m]	0.15	0.31	0.46	0.77	1.5	3.1	6.2	9.3	15.5	46.4	154.6
				IFOV [mm]	0.16	0.32	0.49	0.81	1.6	3.2	6.5	9.7	16.2	48.6	161.9
90° x 66° Super wide angle lens	7.33 mm	90° 66° 120° 2.32 mrad	0.2 m*	HFOV [m]	0.20	0.41	0.61	1.0	2.0	4.1	8.1	12.2	20.3	60.8	202.8
				VFOV [m]	0.13	0.26	0.36	0.65	1.3	2.6	5.2	7.8	13.0	39.0	129.9
				DFOV [m]	0.36	0.71	1.1	1.8	3.6	7.1	14.2	21.4	35.6	106.8	356.1
				IFOV [mm]	0.23	0.46	0.70	1.2	2.3	4.6	9.3	13.9	23.2	69.6	231.9

PSC-764-1M 764 x 480 pixels 322 x 288 pixels	Focal Length	Angle	Min. Distance	Distance to Object											
				m	0.2	0.3	0.5	1	1.5	2	4	6	10	30	100
51° x 40°	6 mm	51° 40° 64° 2.50 mrad	0.2 m	HFOV [m]	0.19	0.29	0.48	0.96	1.4	1.9	3.8	5.7	9.6	28.7	95.5
				VFOV [m]	0.14	0.22	0.36	0.72	1.1	1.4	2.9	4.3	7.2	21.6	72.0
				DFOV [m]	0.25	0.38	0.63	1.3	1.9	2.5	5.0	7.5	12.5	37.6	125.5
				IFOV [mm]	0.50	0.75	1.3	2.5	3.8	5.0	10	15.0	25.0	75.0	250.0
27° x 20°	12 mm	27° 20° 3.3° 1.25 mrad	0.2 m	HFOV [m]	0.10	0.14	0.24	0.48	0.72	0.96	1.9	2.9	4.8	14.3	47.8
				VFOV [m]	0.07	0.11	0.18	0.36	0.54	0.72	1.4	2.2	3.6	10.8	36.0
				DFOV [m]	0.12	0.18	0.30	0.60	0.90	1.2	2.4	3.6	6.0	17.9	59.8
				IFOV [mm]	0.25	0.38	0.63	1.3	1.9	2.5	5.0	7.5	12.5	37.5	125.0
20° x 15°	16 mm	20° 15° 25° 0.94 mrad	0.2 m	HFOV [m]	0.07	0.11	0.18	0.36	0.54	0.72	1.4	2.1	3.6	10.7	35.8
				VFOV [m]	0.05	0.08	0.14	0.27	0.41	0.54	1.1	1.6	2.7	8.1	27.0
				DFOV [m]	0.09	0.13	0.22	0.45	0.67	0.90	1.8	2.7	4.5	13.5	44.9
				IFOV [mm]	0.19	0.28	0.47	0.94	1.4	1.9	3.8	5.6	9.4	28.1	93.8
13° x 10°	25 mm	13° 10° 16° 0.60 mrad	0.5 mm	HFOV [m]			0.11	0.23	0.34	0.46	0.92	1.4	2.3	6.9	22.9
				VFOV [m]			0.09	0.17	0.26	0.35	0.69	1.0	1.7	5.2	17.3
				DFOV [m]			0.14	0.29	0.43	0.57	1.1	1.7	2.9	8.6	28.7
				IFOV [mm]			0.30	0.60	0.90	1.2	2.4	3.6	6.0	18.0	60.0
7° x 5°	50 mm	7° 5° 8° 0.30 mrad	1.5 mm	HFOV [m]					0.17	0.23	0.46	0.7	1.1	3.4	11.5
				VFOV [m]					0.13	0.17	0.35	0.5	0.9	2.6	8.6
				DFOV [m]					0.22	0.29	0.57	0.9	1.4	4.3	14.4
				IFOV [mm]					0.45	0.60	1.2	1.8	3.0	9.0	30.0
4° x 3°	75 mm	4° 3° 5° 0.20 mrad	2.0 mm	HFOV [m]						0.15	0.31	0.46	0.76	2.3	7.6
				VFOV [m]						0.12	0.23	0.35	0.58	1.7	5.8
				DFOV [m]						0.19	0.38	0.57	0.96	2.9	9.6
				IFOV [mm]						0.40	0.80	1.2	2.0	6.0	20.0

\*Note: The accuracy of measurement can be outside of the specifications for distances below 0.2 m.



Output Alarm Box



Mini Net Box



USB Server

### PROCESS SENSORS CORPORATION

IR Temperature Sales Office: 787 Susquehanna Avenue, Franklin Lakes, NJ USA • Tel: 201-485-8773, 8772 • Fax: 201-485-8770

Corporate Headquarters: 113 Cedar Street, Milford, MA USA • Tel: 508-473-9901 • Fax: 508-473-0715

Global Offices—Sales and Support: United Kingdom, Poland, Malaysia

www.ProcessSensorsIR.com • irtemp@processsensors.com